



## SPP-N118

- flow meter, batcher, totalizer in wall mounted IP 67 case
- 1 input 0/4-20 mA + 1 programmable function input
- 0 or 2 REL / OC outputs
- analogue output: active or passive, power supply output: 24V DC
- RS-485 / Modbus RTU
- display of instantaneous and the total flow values
- batching and counting of doses
- free configuration software S-Config

The **SPP-N118** flow counters are encased in a tight, wall-mounted housing (IP 67) and designed to work together with flow transducers equipped with analogue input. The purpose of flow counters is to measure the instantaneous flow value and to record the total flow of media like liquids, gases or loose materials. A wide range of total flow indication (up to 16 digits) allows controlling the flow value for a long operation time. Thanks to the built-in batcher function the **SPP-N118** counters can be used in many industries like: food, pharmaceutical or paint and varnish industry. The REL / OC control outputs can be programmed depending on the instantaneous flow value, batcher or total flow value. Additionally the counter may be equipped with analogue outputs, according to the customer selection: active current output, passive isolated current output or active voltage output. The counter may be configured with no need to open the case, by using the remote controller or with free S-Config software via the RS-485 communication port.

### TECHNICAL DATA

Power supply	19V ÷ 50V DC; 16V ÷ 35V AC or 85 ÷ 260V AC/DC, all separated
Power consumption	for 85 ÷ 260V AC/DC and 16V ÷ 35V AC power supply: max. 5 VA; for 19V ÷ 50V DC power supply: max. 5 W
Display	LED, 6 x 13 mm high, red, brightness adjustable in 8 steps
Displayed values range	0 ÷ 999999 + decimal point
Inputs	current: 0 ÷ 20 mA or 4 ÷ 20 mA, overload-protected, sinking current limited to ca. 40 mA, input resist.: < 65 Ω (typ. 50 Ω) programmable: binary 24V DC, not separated
Input levels	low level: 0 V ÷ 1 V, high level: 10 V ÷ 30 V (about 12 mA @ 24V)
Accuracy	0.1% @25°C ± one digit (for 0 ÷ 20 mA range)
Stability	50 ppm/°C
Counter capacity	total flow: over 4 x 10 <sup>9</sup> m <sup>3</sup> with max. resistance 0,001 l (max. 16 significant digits); batcher: up to 65536 m <sup>3</sup>
Readout precision	instantaneous flow values: selected in the 0 ÷ 0.000 of unit; total flow and batcher: selected in the 0 ÷ 0.000 of unit
Units	instantaneous flow values: l or m <sup>3</sup> per second, minute or hour; total flow and batcher: l or m <sup>3</sup>
Outputs (option)	0 or 2 x REL I <sub>max</sub> =1A, U <sub>max</sub> =30VDC/250VAC (cosφ=1) or OC I <sub>max</sub> =30mA, U <sub>max</sub> =30VDC, P <sub>max</sub> =100mW
Analogue output (available with 1 x REL or OC, see ordering)	active current: operating range 0/4-20 mA (max. 0-24 mA), load resistance 700 Ω max., resolution 13 bit passive current: isolated, operating range 4-20 mA (max. 2,8-24 mA), load resistance 600 Ω@24VDC, resolution 13 bit active voltage: operating range 0/1-5V, 0/2-10V (max. 0-11V), load resistance min. 2000 Ω, resolution 13 bit
Power supply output	24V DC +5%, -10% / max. 100 mA, stabilized
Communication interface	RS-485, 8N1 and 8N2, 1200 bit/s ÷ 115200 bit/s, Modbus RTU (not galvanically isolated)
Data memory	non-volatile memory, EEPROM type
Operating temperature	0°C ÷ +50°C (standard), -20°C ÷ +50°C (option)
Storage temperature	-10°C ÷ +70°C (standard), -20°C ÷ +70°C (depending on option)
Protection class	IP 67
Case	wall mounting; material: ABS + polycarbonate (standard); 100% polycarbonate (on request)
Glands	M12, cable diameter 3 ÷ 6,5 mm
Dimensions (WxHxD)	without glands: 110 x 80 x 67 mm; with glands: 110 x 105 x 67 mm
Weight	max. 350 g



HISPACONTROL S.L.  
Pº Delicias 65 Bis  
28045 Madrid  
Tel. 915 308 552  
hc@hispacontrol.com  
www.hispacontrol.com

**DIMENSIONS**

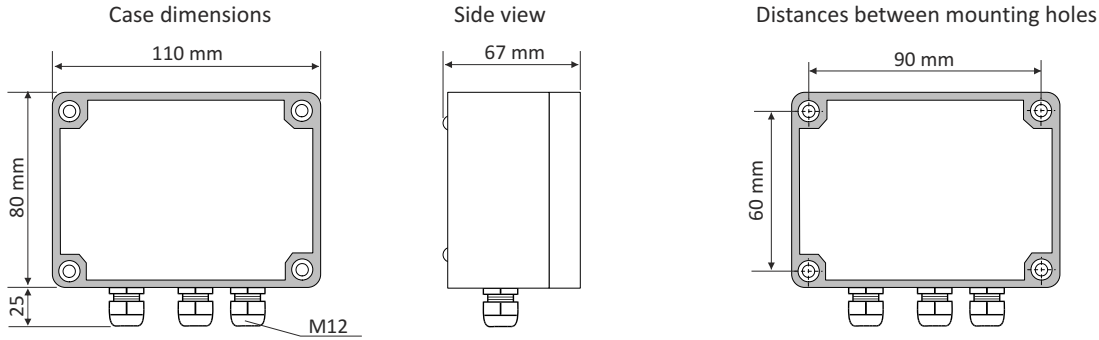

**EXAMPLARY PIN ASSIGNMENTS**

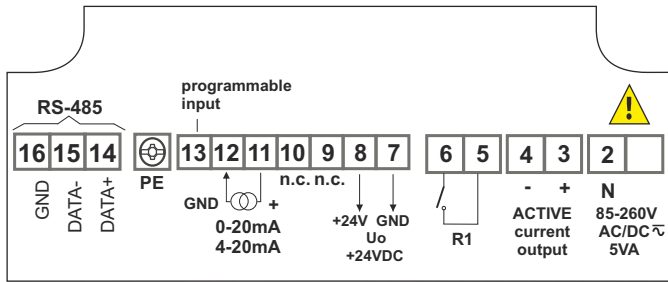

version with 1 x REL and 1 x AO 0/4-20 mA, active

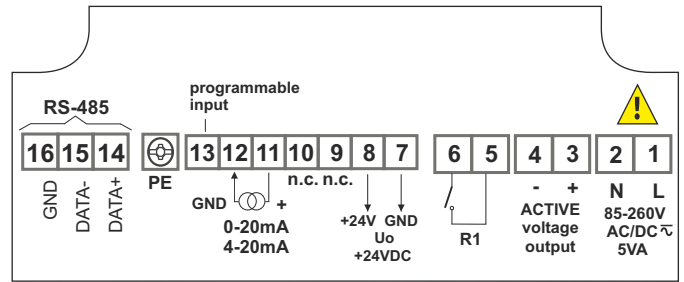

version with 1 x REL and 1 x AO 0/1-5V, 0/2-10V, active

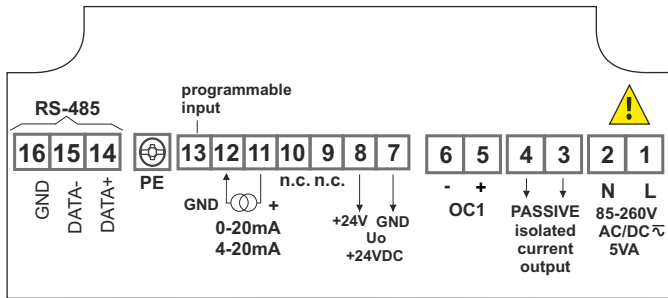

version with 1 x OC and 1 x AO 4-20 mA, passive

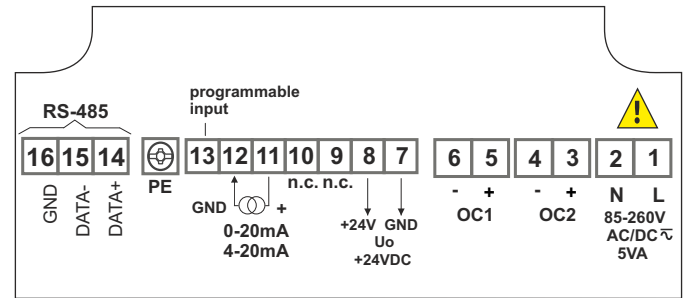

version with 2 x OC

**ORDERING**

SPP-N118-11XX-1-X-XX1

**number of outputs:**

- 0
- 2

**options:**

- 00 : no options
- 08 : operating temp. -20°C ÷ +50°C

**type of outputs:**

- 0 : no output
- 1 : 2 x REL
- 2 : 2 x OC
- 3 : 1 x REL + 1 x AO (0/4-20 mA, active, non-isolated)
- 4 : 1 x OC + 1 x AO (0/4-20 mA, active, non-isolated)
- 9 : 1 x REL + 1 x AO (4-20 mA, passive, isolated)
- A : 1 x OC + 1 x AO (4-20 mA, passive, isolated)
- B : 1 x REL + 1 x AO (0/1-5V, 0/2-10V, active, non-isolated)
- C : 1 x OC + 1 x AO (0/1-5V, 0/2-10V, active, non-isolated)

**power supply:**

- 3 : 24V AC/DC
- 4 : 85V - 260V AC/DC



## REMOTE CONTROLLER



### SIR-15

InfraRed remote controllers may be used as external programming keyboard for all SIMEX devices equipped with IR receivers and remote programming functions. Pressing of any local IR controller key, causes transmission of it's code to the device. Functions of particular keys depend on devices features.

Power supply voltage: 6V DC - 4 alkaline batteries type LR44  
 Operation range: from 0,5 to 5 m (depend on programmed device features)

## SOFTWARE

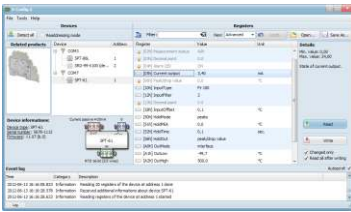

**S-Config 2** is used for the simultaneous detection of devices in multiple Modbus RTU networks and allows user to change the configuration of most of them. For each detected device a list of its registers, which the user can modify, is displayed and also additional informations about device parameters (type, address in the network, etc.).

**S-Config** software can be downloaded from SIMEX website at [www.simex.pl](http://www.simex.pl)

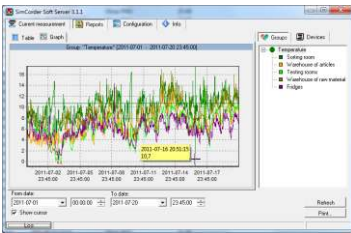

**SimCorder Soft** is a visualisation application created to facilitate work with advanced networks of the SIMEX devices, for acquisition, visualisation, reporting, archiving, exporting and printing of measurement data from all network devices. You can download measurements from the devices automatically or on demand. There is a possibility of immediate notification about emergency states via SMS or e-mail, which will often allow to quickly resolve an arising problem while avoiding long and expensive stoppages. You can view the measurement data, emergency states and configuration via the internet at every time.

## CONVERTERS



The **SRS-U4** module is designed to connect a USB host to slave devices equipped with RS-485 interface. The PC with special software can be used as a host. The **SRS-U4** unit guarantees full galvanic isolation between USB and RS-485 circuits. The converter can work with any devices equipped with RS-485 interface and contains integrated circuit which supports USB 1.1 and USB 2.0 standards. The main purpose is connection of PC host computer with industrial data acquisition and visualisation systems based on RS-485 interface.

The **SRS-U4** can be also manufactured with DIN mounting adaptor.

